

Write the Beginning Sound!

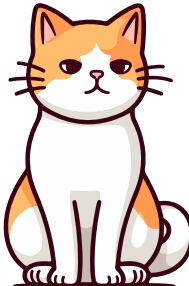

ig



at

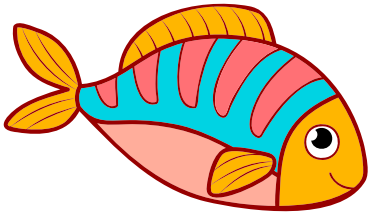

ish



tar

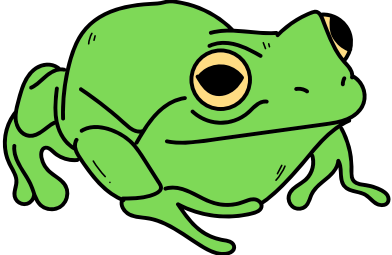

rog



ird



up

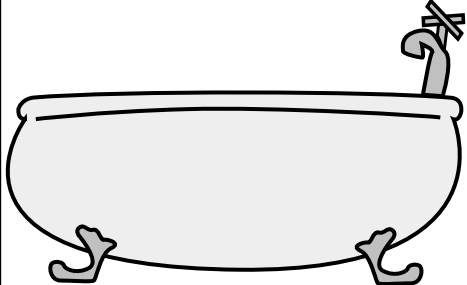

ub

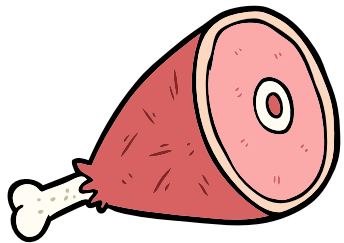

am

Write the Beginning Sound!

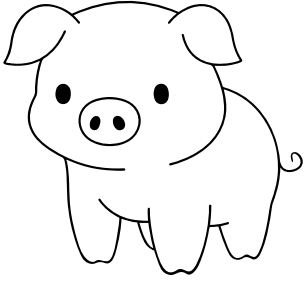

ig

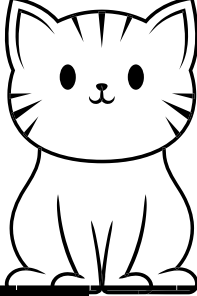

at

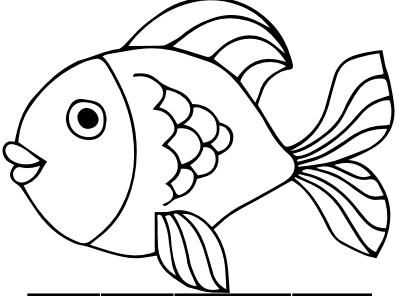

ish

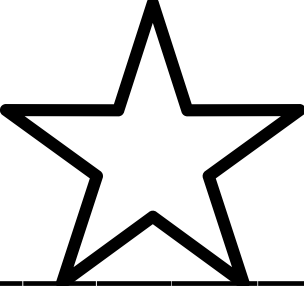

tar

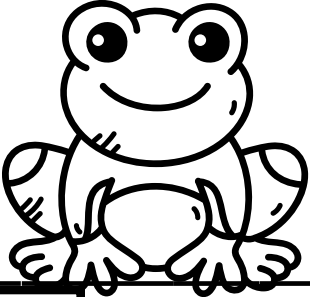

rog

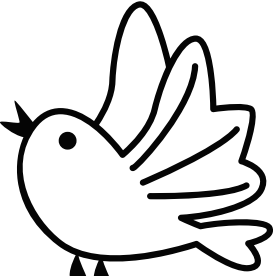

ird



up

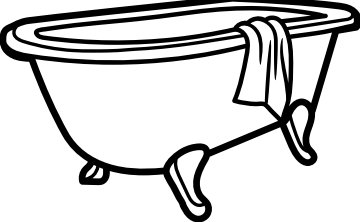

ub

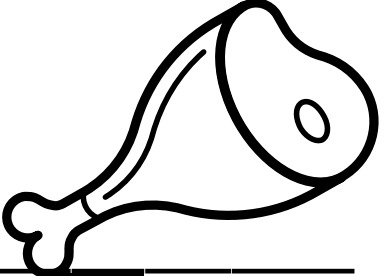

am

Write the Beginning Sound!

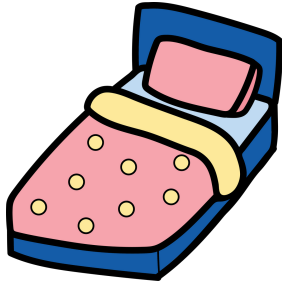

[] e d



[] o p

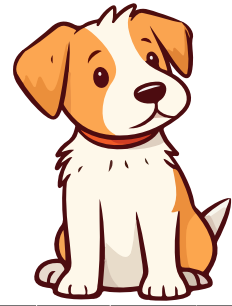

[] o g



[] o u s e



[] c h o o l



[] o u s e



[] e t





[] e b r a



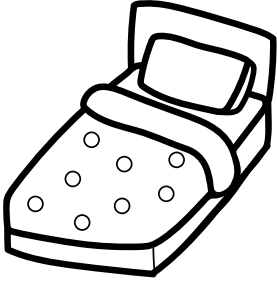

[] h o s t

Write the Beginning Sound!



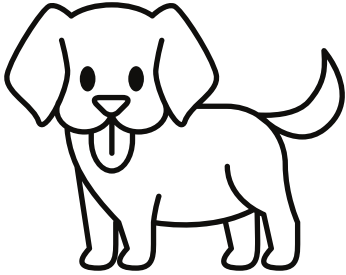







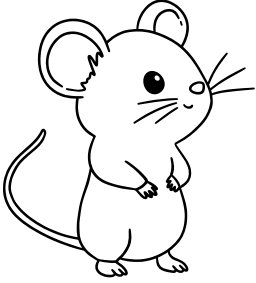

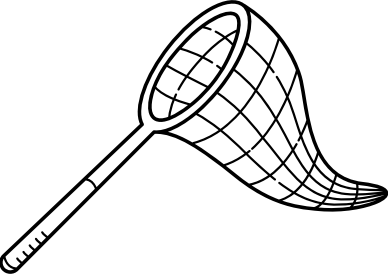





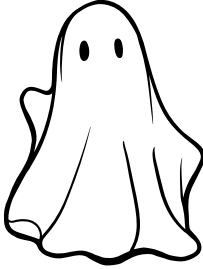

Write the Beginning Sound!

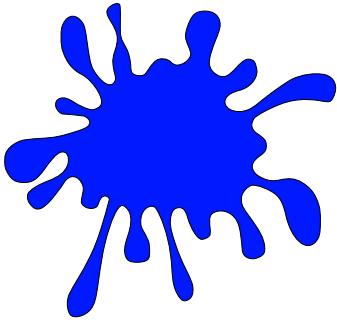

ue

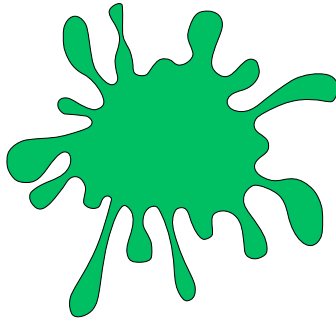

reen

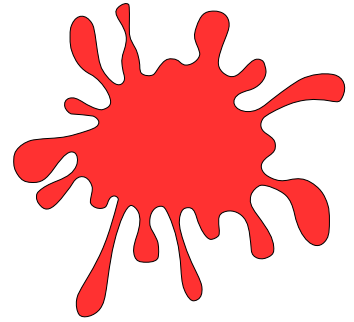

ed

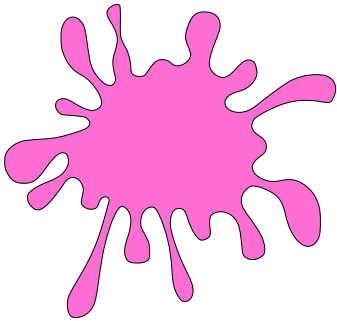

ink

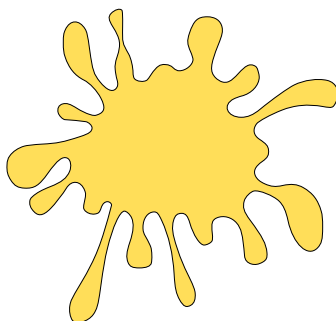

ellow

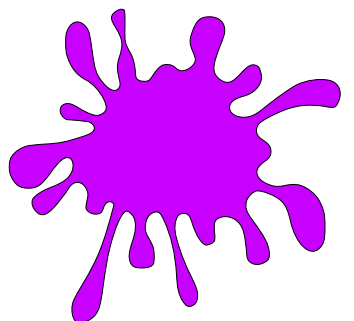

urple

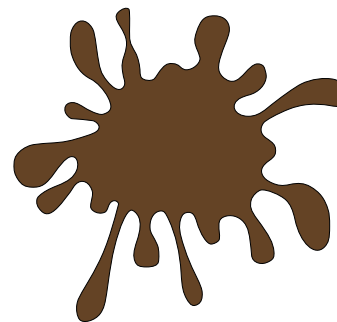

rown

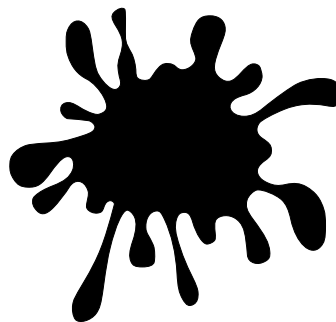

lack

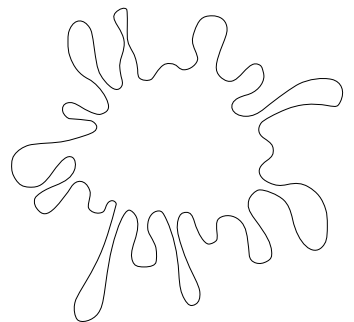

hite

Write the Beginning Sound!

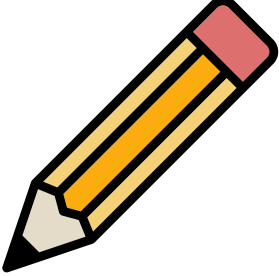

encil

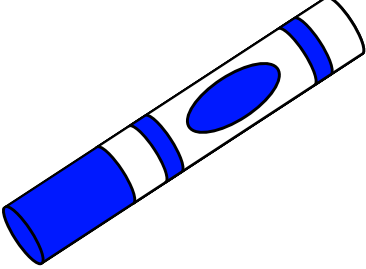

arker



issors



ue

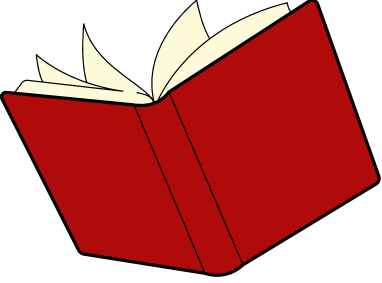

ook



eacher



ack
pack



unch

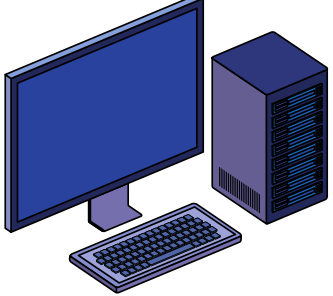

omputer

Write the Beginning Sound!

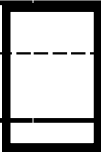
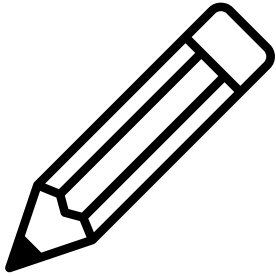

encil

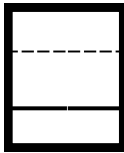
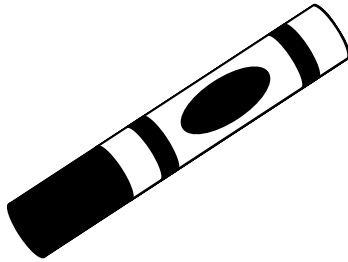

arker

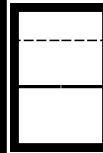
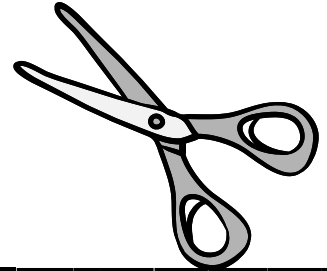

issors

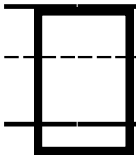
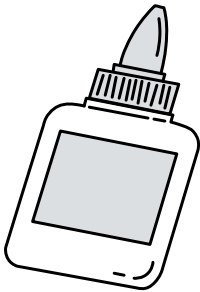

lue

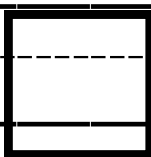
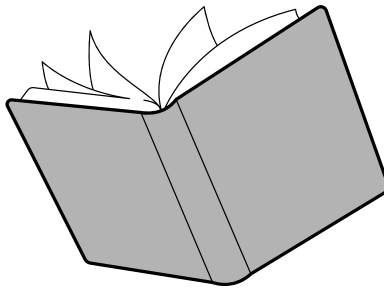

ook



eacher

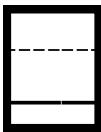

ack

pack

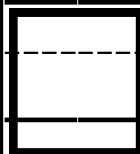
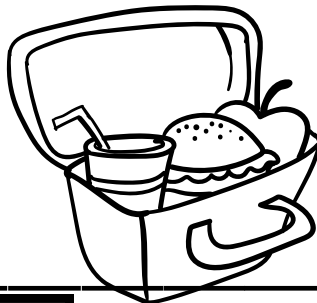

unch

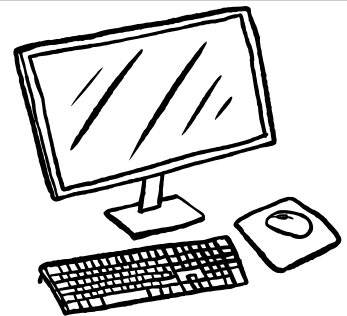

omputer

Write the Beginning Sound!

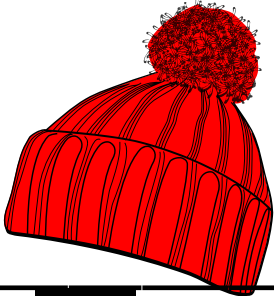

at

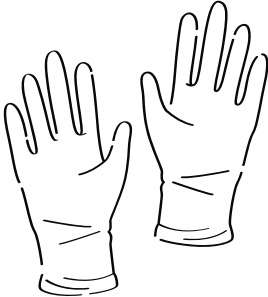

loves



locks

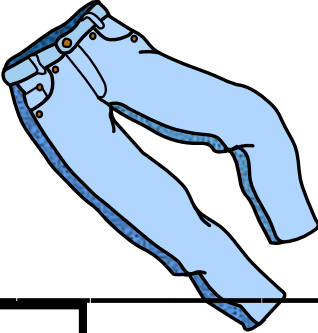

jeans



skirt



dress

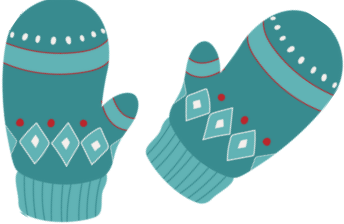

mittens



coat



scarf

Write the Beginning Sound!

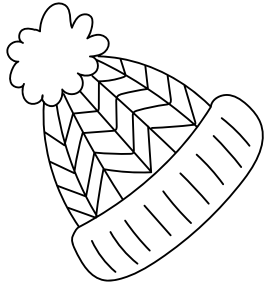

at

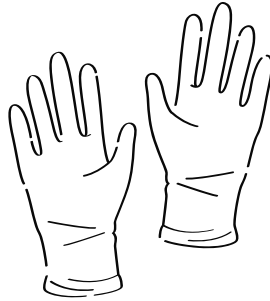

loves



ocks

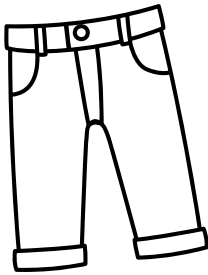

eans



irt

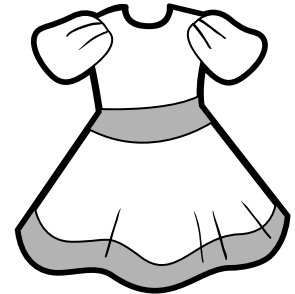

ress

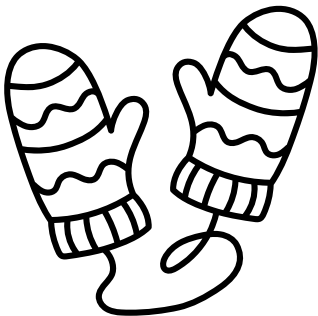

ittens



oat

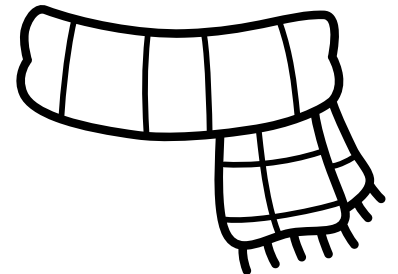

scarf

Write the Beginning Sound!



tent



asket



rass



river

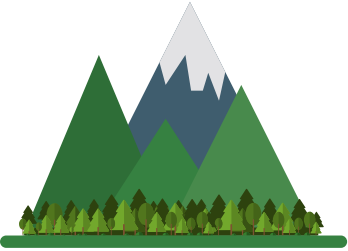

ountain



ragon
fly

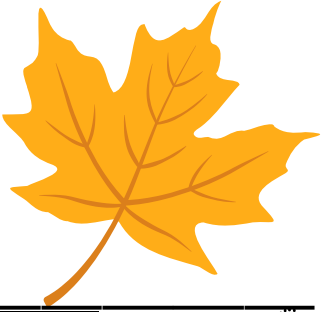

eaf

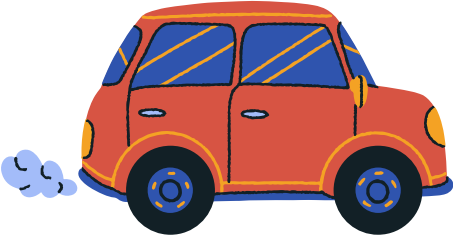

ar



ire

Write the Beginning Sound!

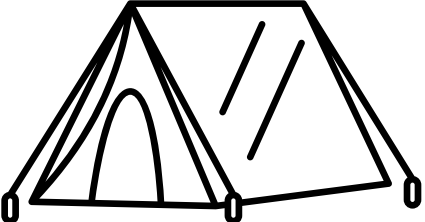

ent



asket



rass



river

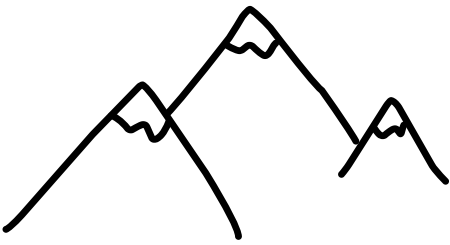

ountain

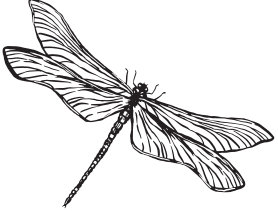

ragon
fly



leaf

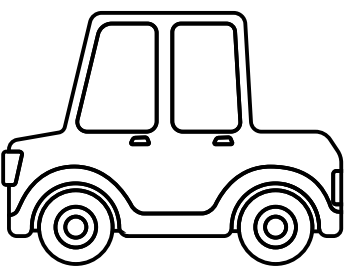

car



fire